



craster

LINE TABLE

Compact Folding Table



craster



Introducing Line Table

SEAMLESS SET-UP AND STORAGE

Intuitive locking system, core and ergonomic grip for seamless set-up, breakdown and changeover.

A patented folding system collapses the legs down to 43 mm (1.7 inches) for streamlined stacking within a self-contained storage trolley.

STABLE AND DURABLE

Featuring a rigid frame reinforced with bracing table-top element and a near-indestructible edge.

WORKS WITH YOUR SPACE

Two-size series: 1500 mm (5 foot) and 1800 mm (6 foot). Choose from rectangular, classroom, trapezoid and half round surfaces to create custom layouts.

Added panels, power banks and cable management solutions deliver exceptional, sleek experiences.



craster

Line Table

Intuitive locking system, ergonomic grip for seamless set-up, breakdown and changeover. No tools required.

1

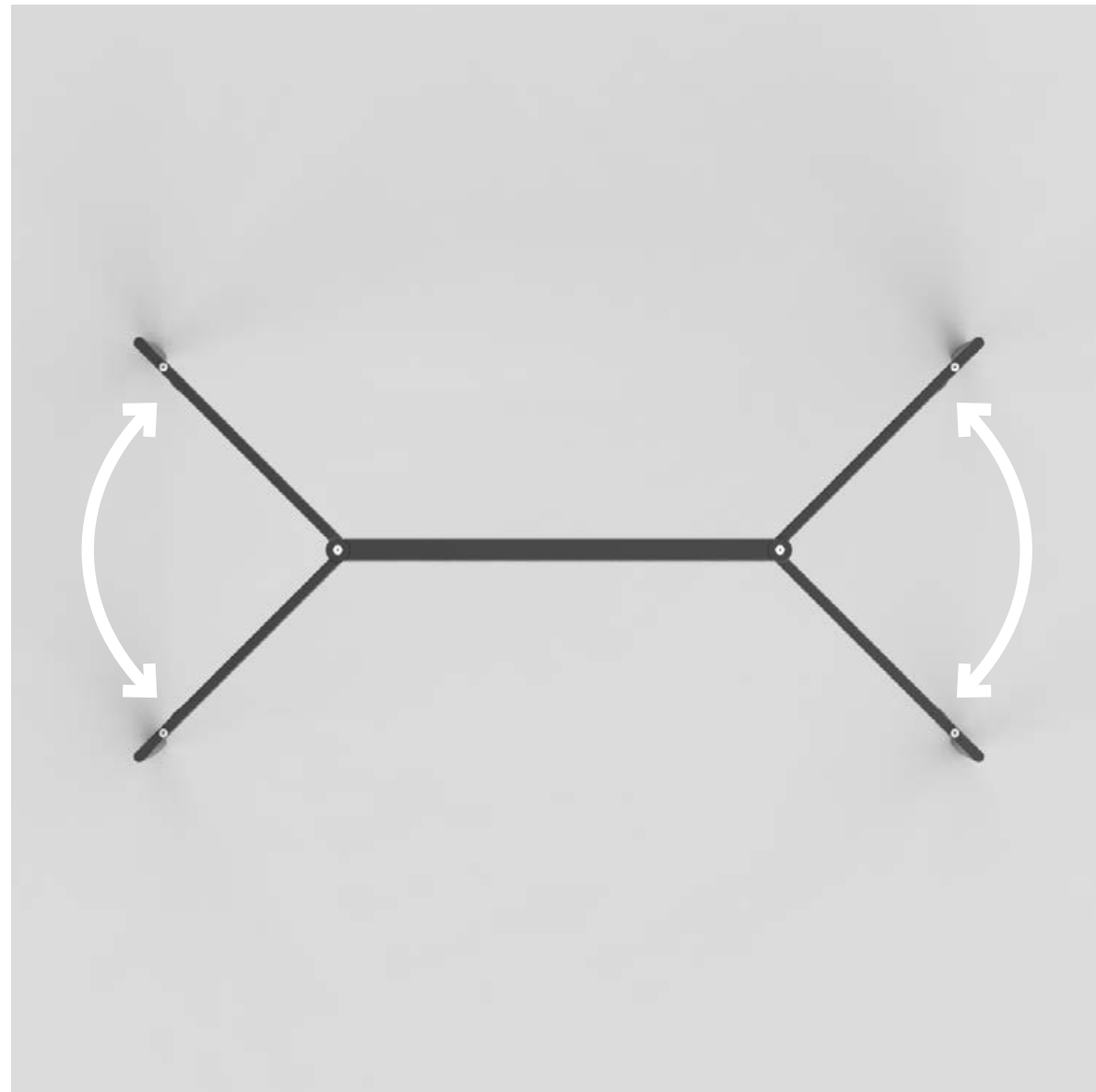

Open legs as wide as they go

2



Lift top onto legs – make sure that the locator plates sit on the pins

3

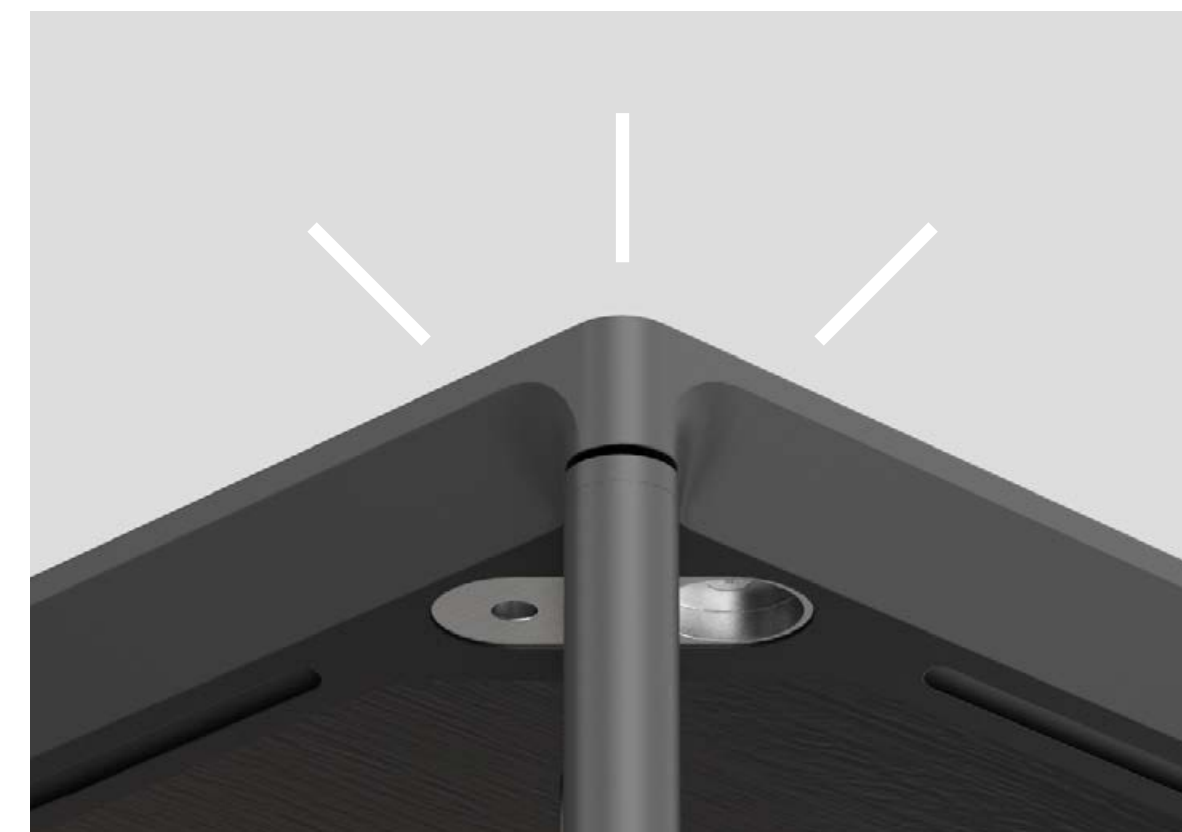
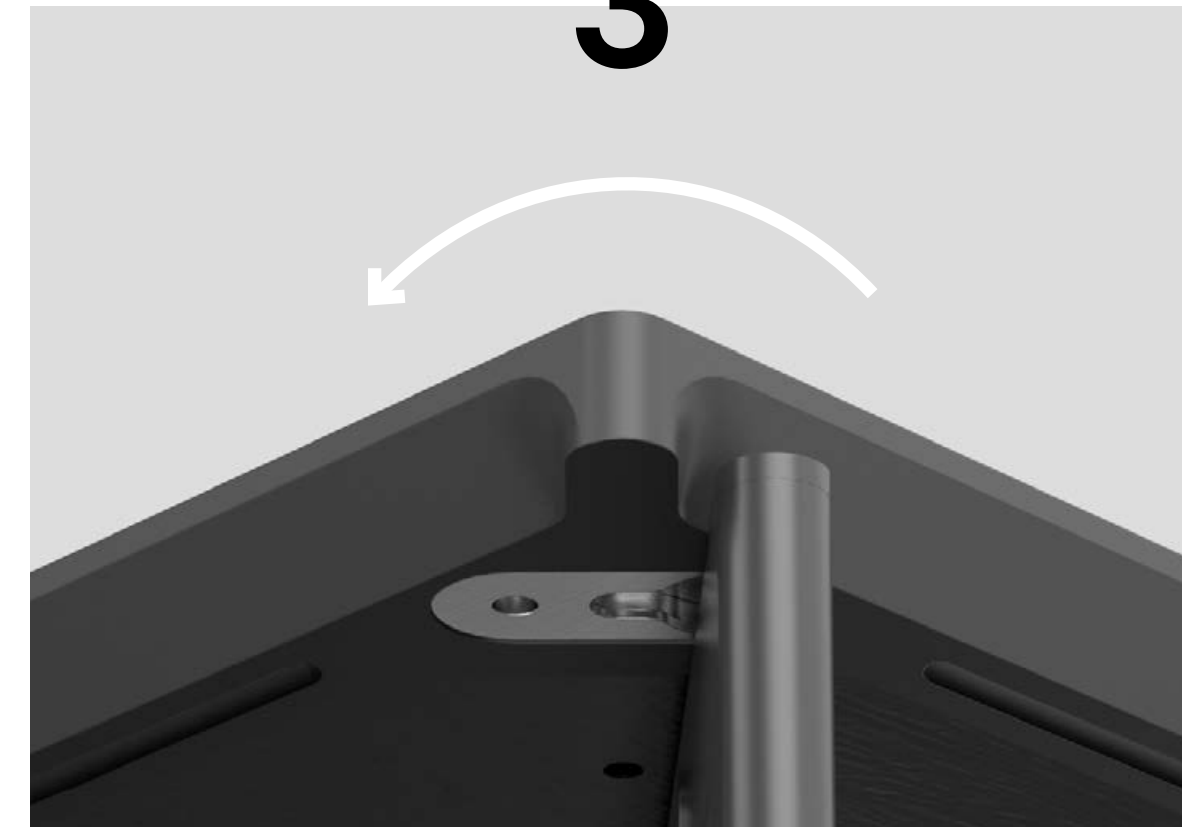

Pull the legs back in to lock with locator plates

4



Table is ready to use

1800 Range

1800 x 900 mm
71 x 35.4"

1500 Range

1500 x 750 mm
59 x 29.5"

Table Tops

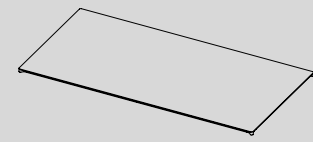

1800
Rectangle

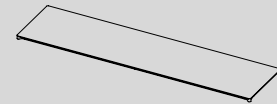

1800
Classroom

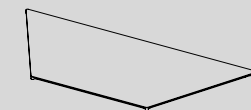

1800
Trapezoid / Half Round

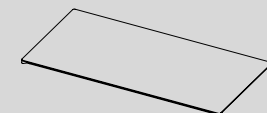

1500
Rectangle

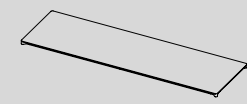

1500
Classroom

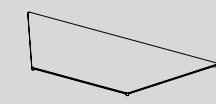

1500
Trapezoid / Half Round

Legs

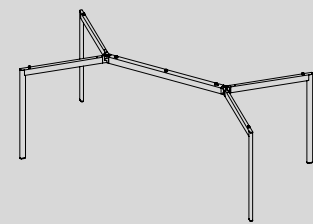

1800
Rectangle

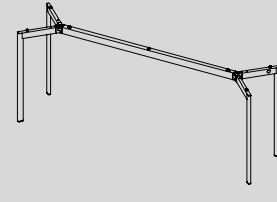

1800
Classroom

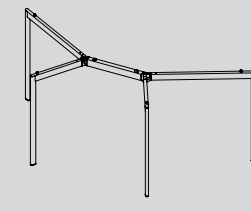

1800
Trapezoid / Half Round

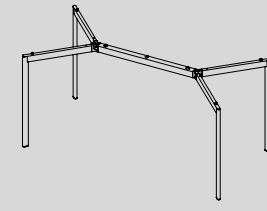

1500
Rectangle

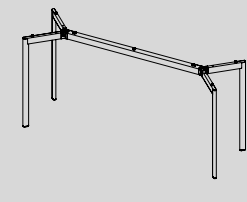

1500
Classroom

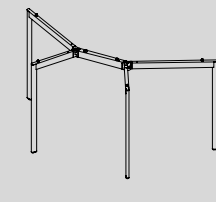

1500
Trapezoid / Half Round

Storage Trolleys

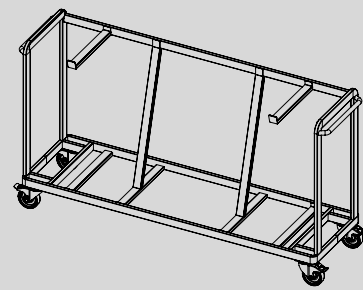

1800
Rectangle / Classroom

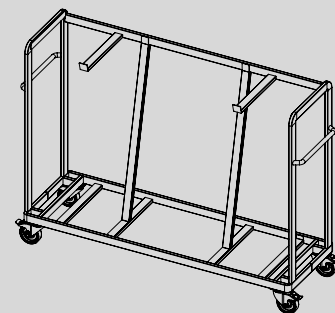

1800
Trapezoid / Half Round

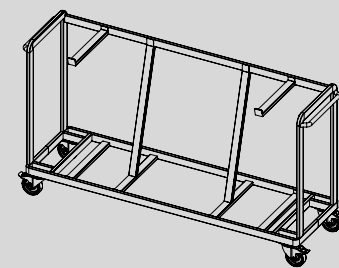

1500
Rectangle / Classroom

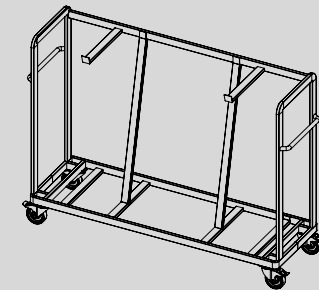

1500
Trapezoid / Half Round

Modesty Panels

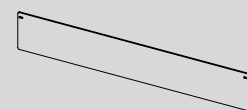

1800

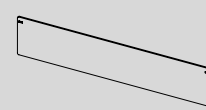

1500

Cable Management

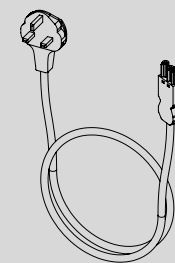
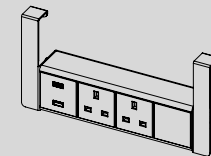

craster

Line Table Anatomy

The Line Table System is available in two sizes – 1500 mm (5 foot) and 1800 mm (6 foot) – and in four different shapes – rectangular, classroom, trapezoid, and half round – to create various configurations to suit any space requirement.

Line consists of five different elements: table tops, legs, modesty panels (optional), cable management (optional), and trolleys (mandatory).

Materials and Colours

Table Tops And Edge

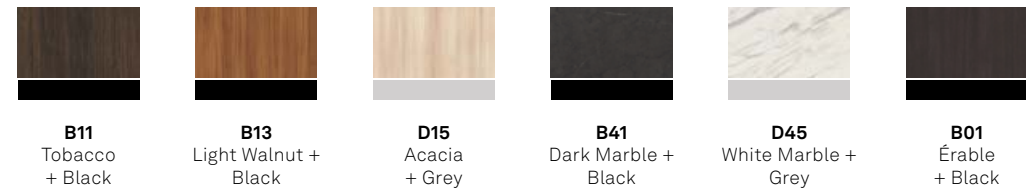

Legs

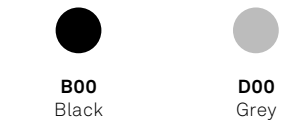

Modesty Panel



Storage Trolley



Boardroom

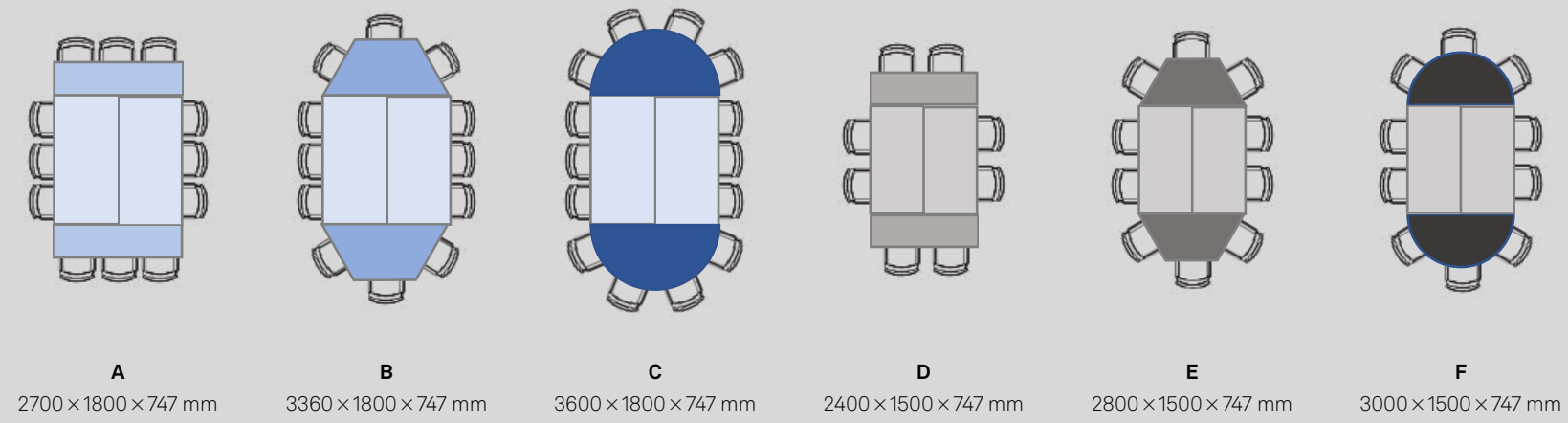

U-Shape

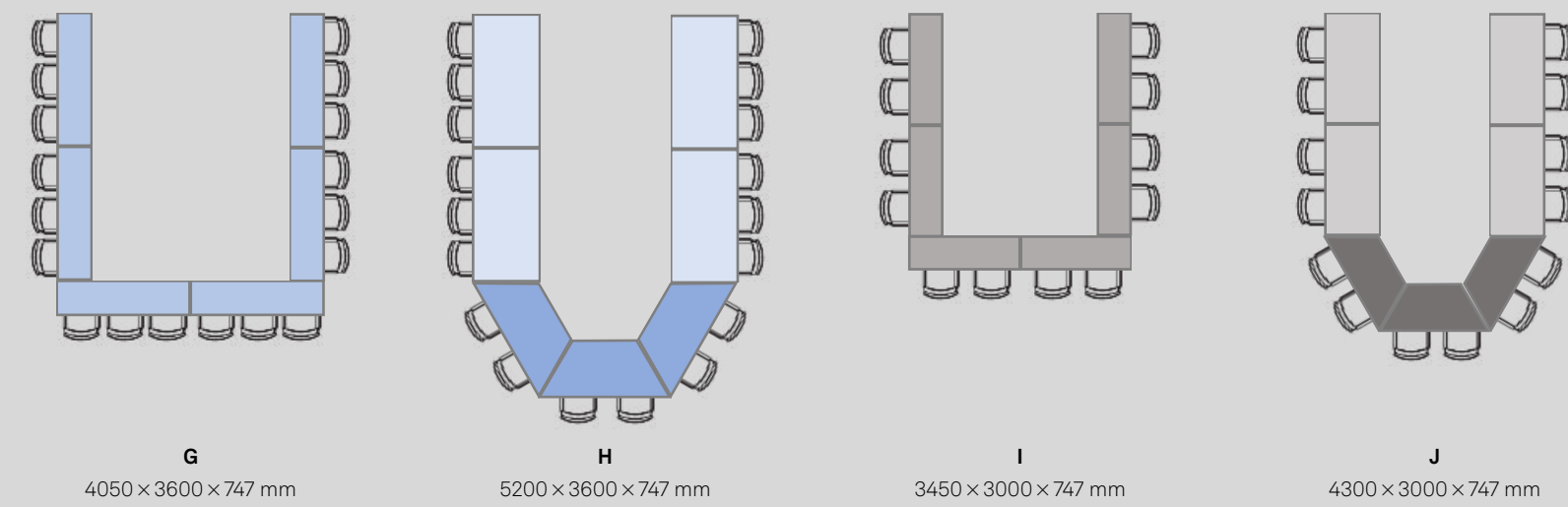

Classroom



Round Tables

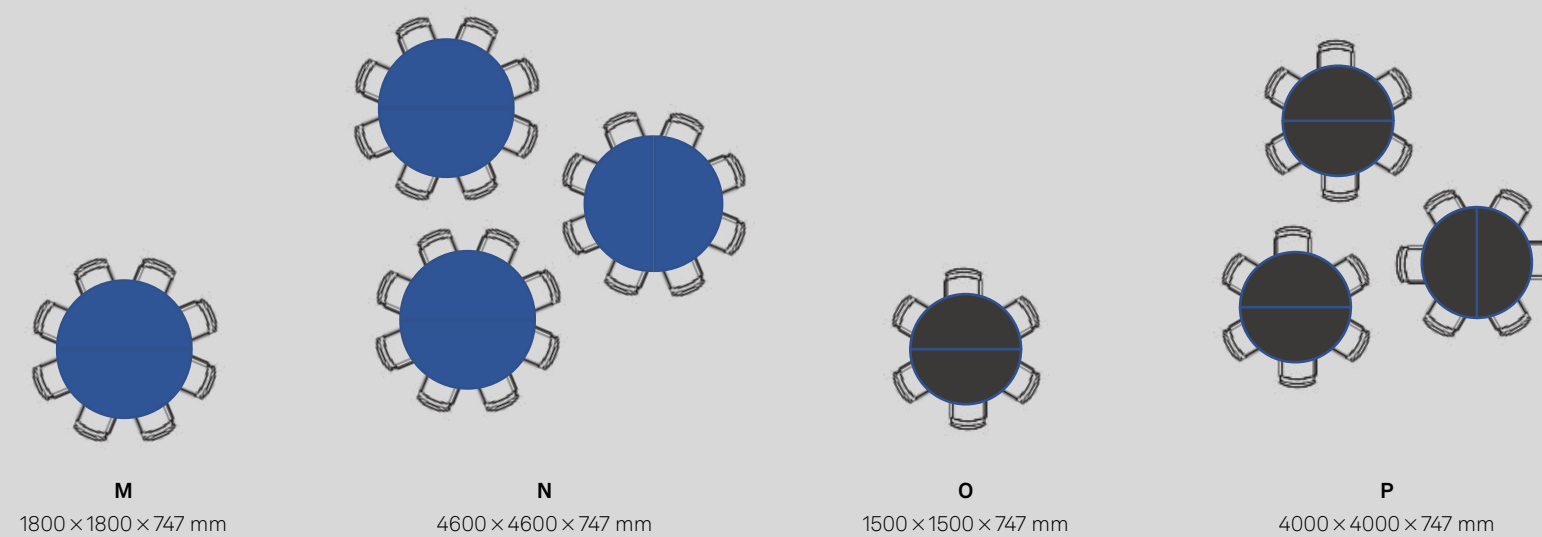

craster

Line Table Specification

Line Table tops are engineered from HPL with a durable Reef edge; table legs are available in complementing colours.

Craster recommends the material and colour pairings at left. Bespoke options are available upon request.



craster

Line Table

Line is a unique folding conference table solution at the forefront of event space design, combining discreet elegance with true operational innovation.

Line Table offers a contemporary, residential aesthetic to fit into any environment. The lightweight tops and compact folding leg system combine to offer advances in the evolution of linen-less table design.

[Watch the Line Table animation.](#)



craster

Line Table Aesthetic

Line is Craster's new linenless conference table range, offering a contemporary aesthetic that fits discreetly in any environment.

The range is a versatile table system, intelligently designed for efficient set up and break-down. Offering great functionality, ergonomics and flexibility, Line addresses the key challenges of operating in the demanding conference and events sector.







craster

Line Table Power

Line Table power units have been designed to fit discreetly beneath desks, with a subtle cable management sleeve to reduce trip hazards and unsightly wires. Equipped with male and female sockets, each unit can be daisy chained together, with magnetic clips provided to channel cables discreetly along table frames. Intelligently-designed USB A and C outlets for mobile and laptop charging may be toggled in and out and replaced without affecting adjacent sockets.

Available in North American, EU (Schuko), UK/IRL, and Japanese sockets as standard.

Other regional sockets available upon request.



craster

Line Table Modesty Panels

A subtle addition for presentation tables to shield legs and wires, the Modesty Panel forms part of the dynamic Line Table System in 1500 mm (5 foot) and 1800 mm (6 foot).

Available in black and light grey.

Materials and Colours



B00
Black



D00
Light Grey

craster

Follow us for the latest Craster news.



(UK) +44 (0)203 004 4750

(USA) +1 732 543 7862

info@craster.com

[Download the latest version of our catalogue.](#)

